

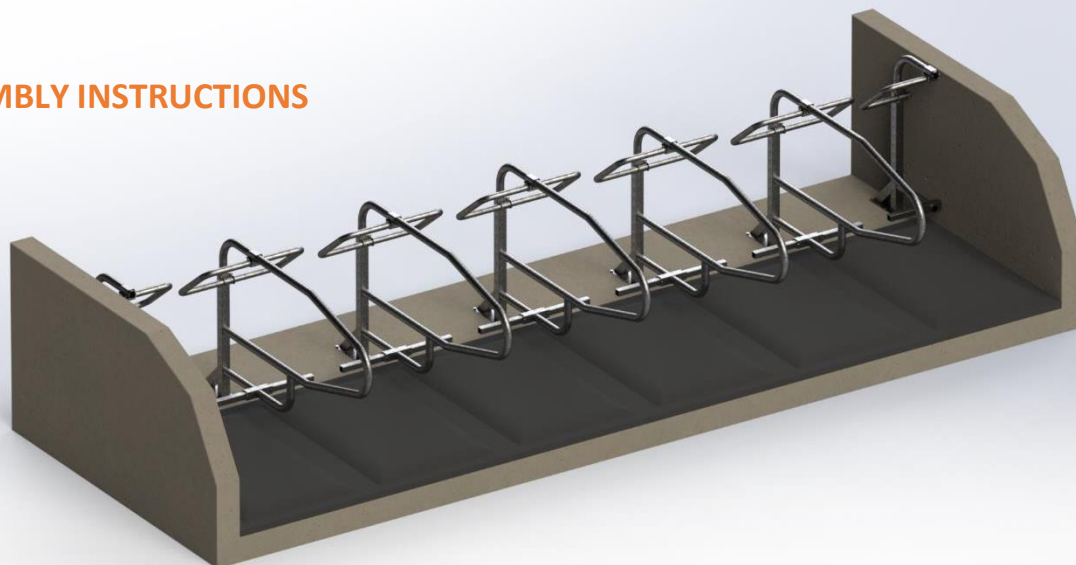

OMEGA ANIMAL STALL

ASSEMBLY INSTRUCTIONS



REQUIRED TOOLS:

- Perforator with drill bit \varnothing 12
- Rope (Rope or String)
- Meter/ Decameter
- Impact wrench with long sockets \varnothing 13, 17, 19
- Hammer

Position each side bar at the ends of each block against the wall:

- The back of the side bar (at the bottom of the post) at 201cm* from the back of the stall. Fig.1
- Mark the widths between each side bar: first mark at 120cm* (center of the mounting plate) then every 120cm*. Fig.2/3
- Secure the assembly with 6 dowels. Fig.4
- Stretch the line as shown below (in blue on the diagram). Fig.2

*Standard sizes

Positioning the cubicle partition:

- Drill the two front holes (marked in red) through the mounting plate.
- Check the 120 centimeters spacing at the back of the sideboards then fix the assembly with the 6 dowels. Position all the cubicle partitions. Check the positioning with a line stretched between the first two batten blocks

Assemble the accessories and cut the toggle tube on the end posts

- Knee pads : Bolts 10x80 + Locknuts

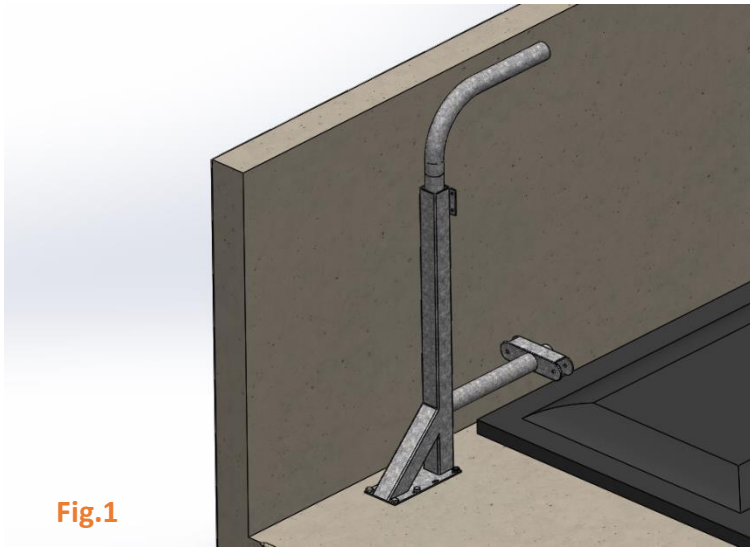

Fig.1

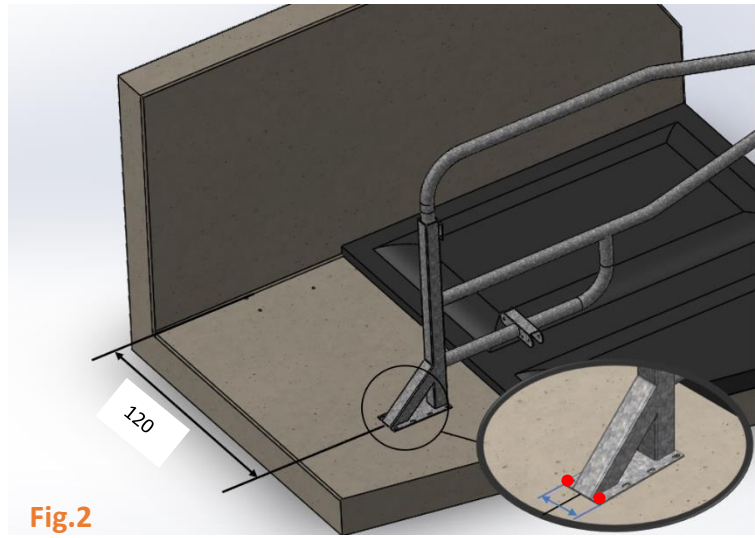

Fig.2

I) PLACE THE KNEE PADS

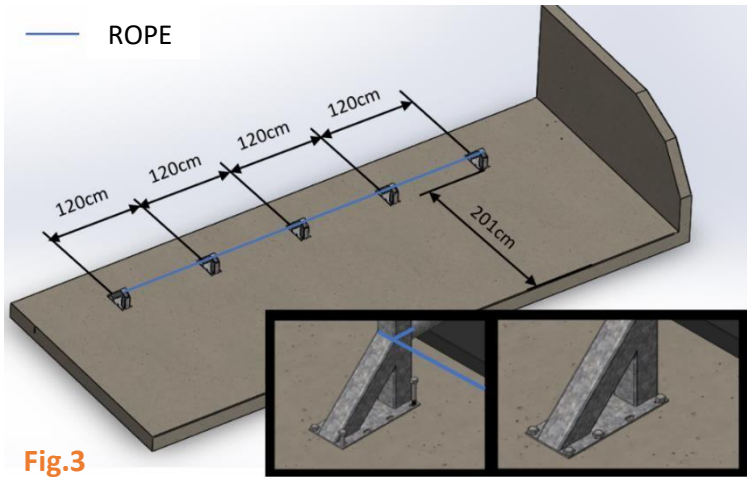

Fig.3

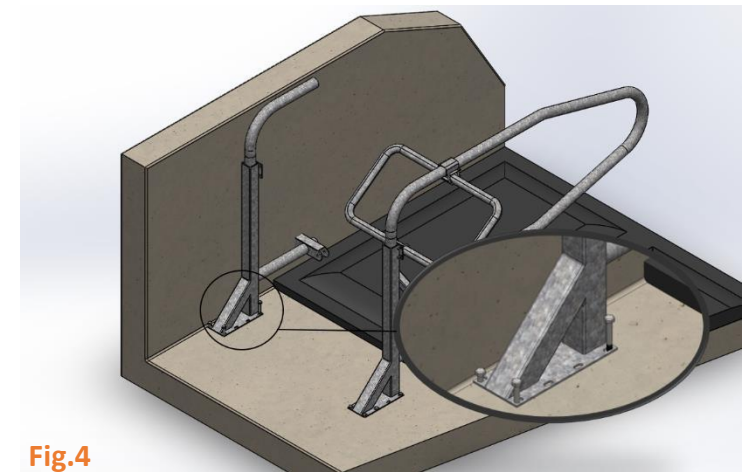
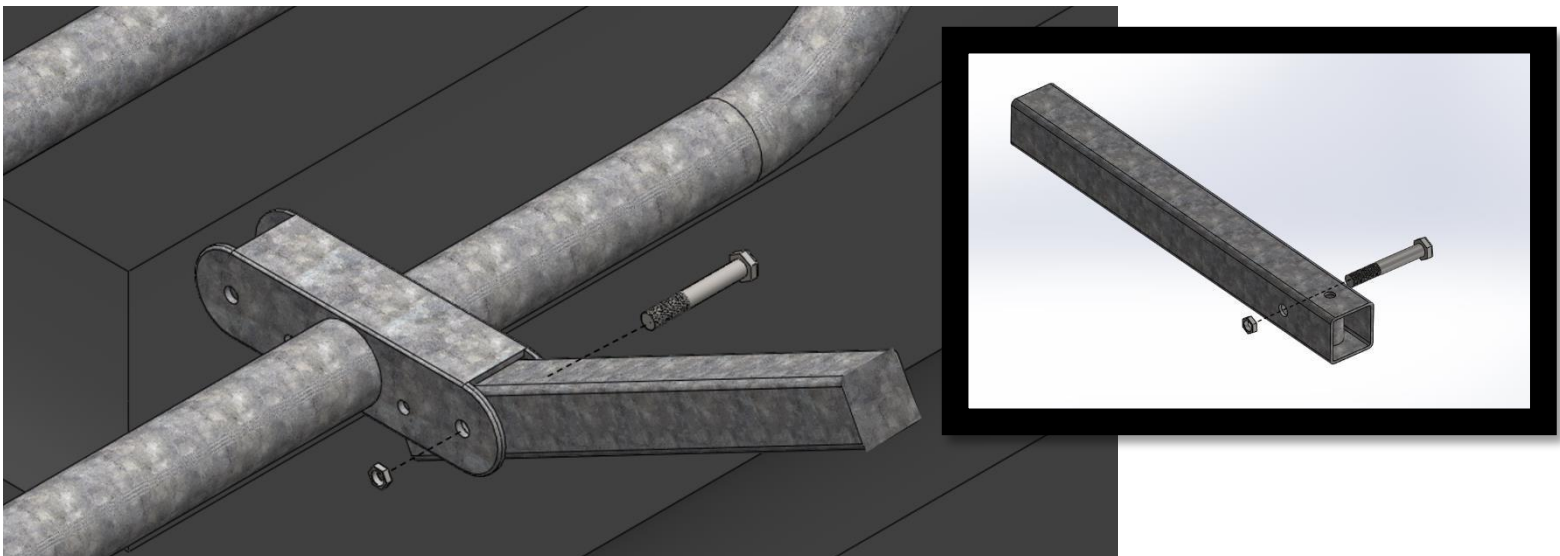
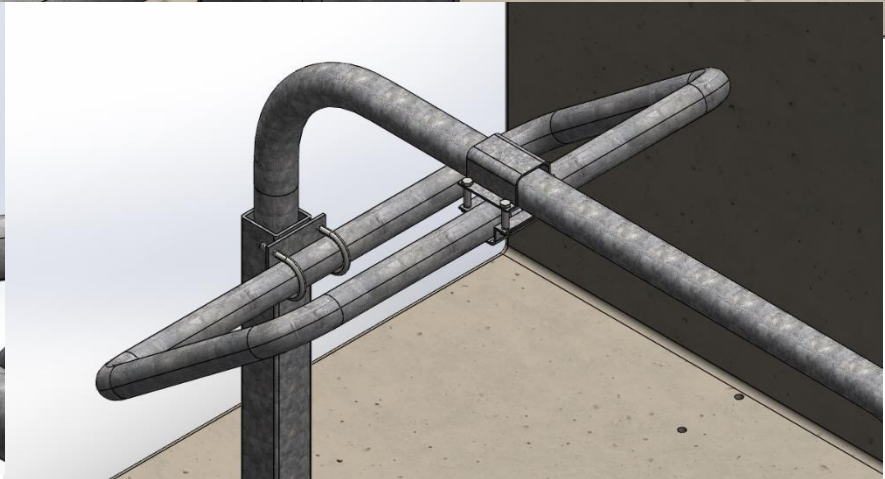
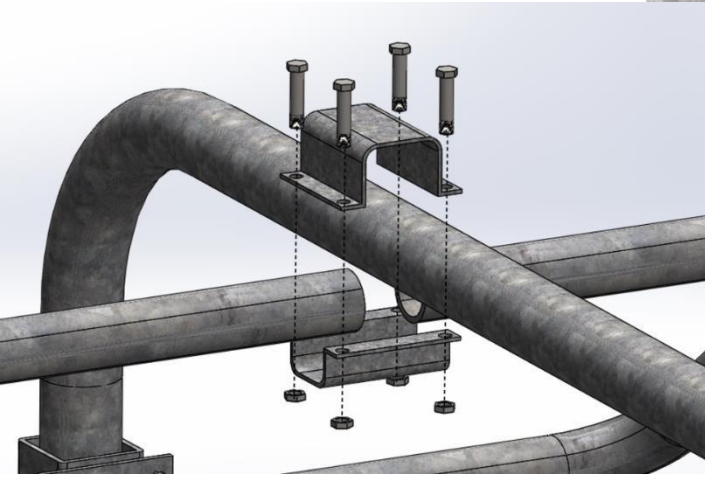
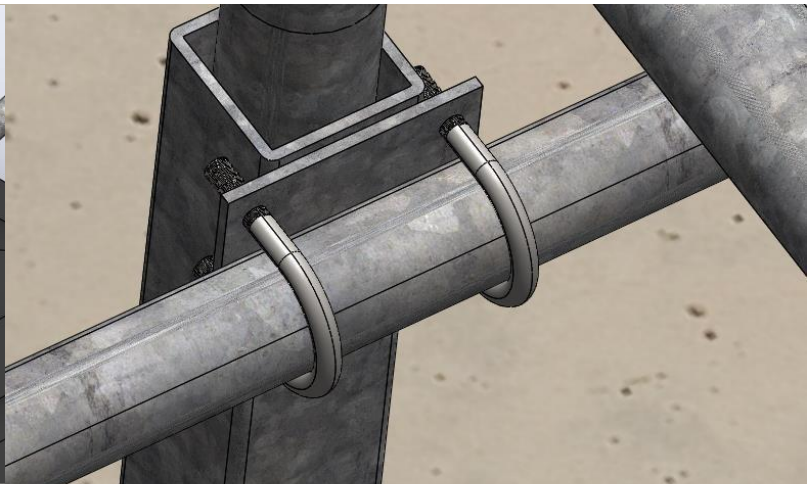
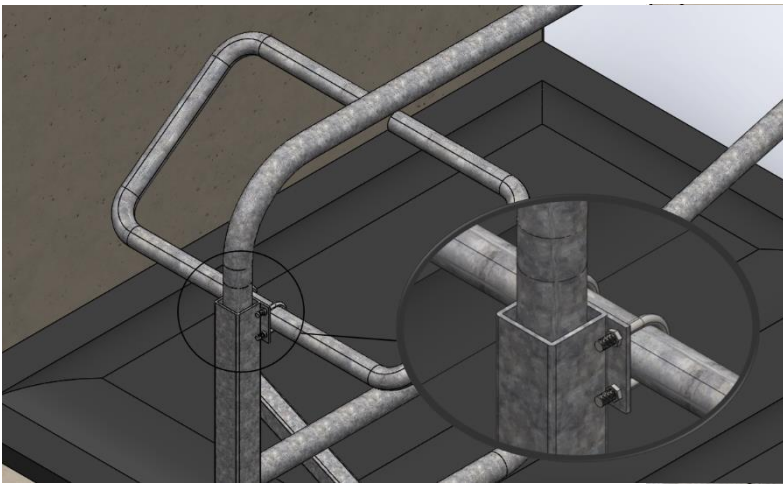

Fig.4

Knee pads:



Arch:



Side bar accessories:

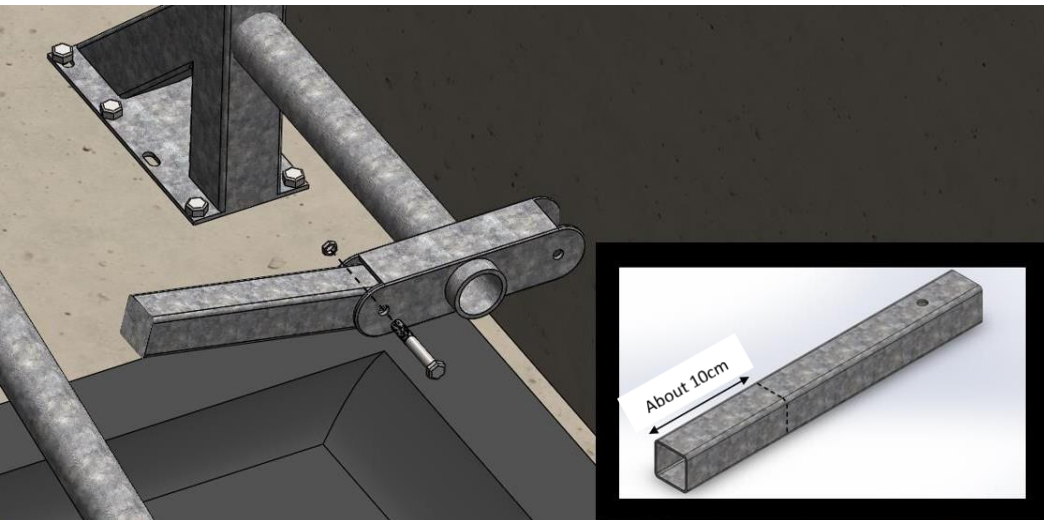

Cutting of the knee pad

